

# MAIOR AND MASTIK CHAIR



Maior and Mastik chairs have a lovely seat comfort, try them and you never want to get up again. The back flex a bit, so you can just sit forever..., if you have the time. Maior and Mastik chairs are tested and approved for public use. They comes in a lot of colours and materials. Maior has edgy legs and Mastik has round legs, so there might be one for everyone . What do you choose?

[www.pbjdesignhouse.com](http://www.pbjdesignhouse.com)

*Designed by  
Morten Svendsen*





### Maior chair

No 8084

Fully upholstered chair with edgy wooden base and flexible back. Tested and approved for public use. Seat height: 47 cm

L 54 W 48 H 82 cm.

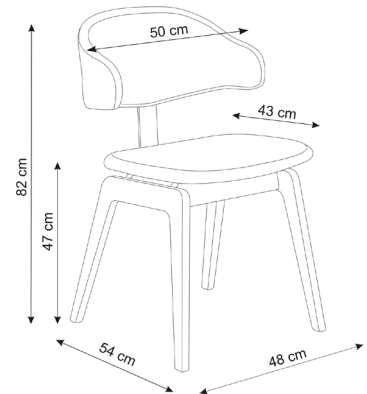

### Mastik chair

No 8085

Fully upholstered chair with round wooden base and flexible back. Tested and approved for public use. Seat height: 47 cm

L 54 W 48 H 82 cm.

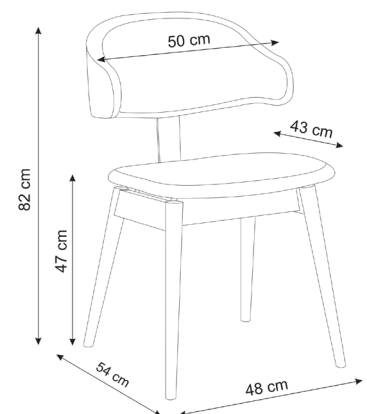























# MAIOR AND MASTIK CHAIRS

Maior and Mastik chairs, designed by Morten Svendsen, have a lovely seat comfort, try them and you never want to get up again. The back flex a bit, so you can just sit forever..., if you have the time. Both chairs are tested and approved for public use. They comes in a lot of colours and materials, please see below. Maior has edgy legs and Mastik has round legs, so there might be one for everyone . What do you choose?



## COLOURS AND MATERIALS

### CHAIR - BASE COLORS

<b>SOLID</b>	 43 Light oak lac	 45 Oak natural oil	 87 Black oak lac	 75 Walnut oil	
<b>LEATHER</b>	 90 Sand	 91 Cognac	 92 Choco	 93 Black	
<b>FABRIC DEVIDE</b>	 20 Bordeaux	 22 Dusty Green	 24 Dusty Charcoal	 26 Dusty Grey	 27 Light Grey
	 28 Dusty Blue	 29 High Blue			
<b>FABRIC CURA</b>	 80 Light Grey	 81 Brown	 82 Charcoal	 83 Mustard	 84 Dark Green
	 85 Petrol	 86 Dark Blue			



### QUALITY FURNITURE SINCE 1968

PBJ Designhouse was founded in 1968 by Per Buhl Jørgensen. Since 1996 the proud design and craftsmanship tradition has been carried on by Morten Svendsen, and the company has invested in larger production facilities to follow the strong demand.

### DANISH DESIGN

PBJ Designhouse has a tradition of bringing together furniture architects and certified cabinet makers since the start.

This has turned the company into an exponent of Denmark's proud traditions in furniture – when creativity and quality unite, the result reaches new heights.

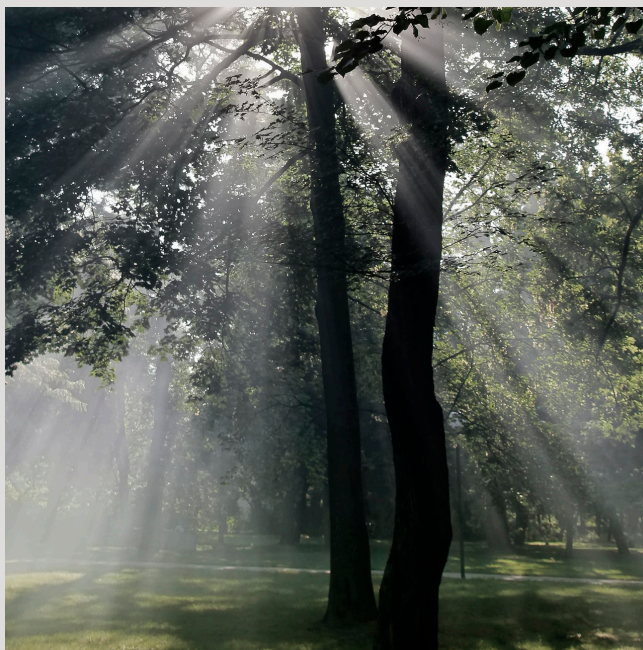

### FURNITURE WITH A CONSCIENCE

All wood used at PBJ Designhouse comes from state approved plantations, where the logs are individually selected and gently harvested.

We often produce furniture with veneer. The reason for this is twofold. It reduces the use of solid timber, thereby conserving natural resources. Secondly, the MDF that the veneer cover is made with recycled wood which is better for the environment whilst still producing a strong and high-quality surface.

All of our timber and veneer are carefully hand sorted so that the grain patterns and color variations are as natural as possible.



**PBJ Designhouse**  
Skovvænget 2  
DK-7860 Spøttrup  
Denmark

pbj@pbjdesignhouse.com  
**pbjdesignhouse.com**

Item: 0010-0052 - Version: 04012022

Your specialist dealer:

*The brochure is subject to technical changes and possible printing errors.*